



Pilot Operation

With left and right pilot operation, soft action, better stability, easy maintenance and low operating cost.

True Tailless Slewing

The whole body does not exceed the width of both sides of the track, so that the slewing operation will not hinder the slewing of the excavator. Easily handle working conditions in narrow terrain.

High-end Configuration

KP25-8 is a tailless excavator, compact, equipped with international brand components Yanmar engine, Hydraulic system: KYB composite control valve; KYB variable displacement plunger pump; KYB travel motors and swing motor.



PERFORMANCE PARAMETER

	Model	KP25-8
	Bucket capacity	0.08 m ³
	Engine model	YANMAR 3TNV88
	Engine power	20.4/2200 kW/rpm
	Max. gradeability	30°
	Max. arm digging force	13 kN
	Max. bucket digging force	23 kN
	Travelling speed	4.4/2.3 km/h
	Slewing speed	9.3 rpm

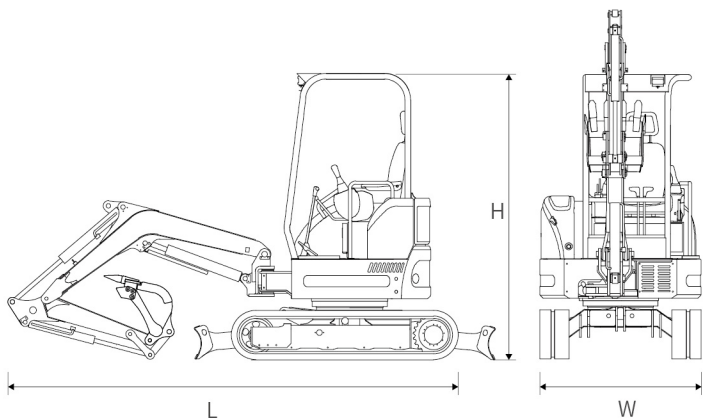

Dimension and Weight



DIMENSION		KP25-8
	Overall length (L)	mm 3832
	Overall width (W)	mm 1380
	Overall height (H)	mm 2435
	Machine weight	kg 2350 ^① /2450 ^②

①: With rubber track, ②: With steel track.

KEYPOWER has the right to modify any feature without prior notice. Weights and dimensions based on standard products. Illustrations may include optional equipment. Technical data described in this catalogue correspond to the available information at the moment of printing. The illustrations and images are indicative and may not coincide in their entirety with the product. Industrial design under patent.

Technical Specifications

OPERATING PARAMETER	KP25-8
Max. digging height	3821 mm
Max. digging depth	2063 mm
Max. digging radius	4208 mm
Max. ground digging radius	4208 mm
Max. dumping height	2577 mm
Min. swing radius (Front end)	1765 (1560) mm
Max. vertical digging depth	1918 mm

OTHER PARAMETER	KP25-8
Track pad width	250 mm
Overall length of crawler	1930 mm
Minimum ground clearance	275 mm
Balance weight ground clearance	520 mm
Tail swing radius	690 mm
Fuel tank capacity	27 L
Hydraulic oil tank capacity	30 L

Product Structure



KP25-8 Details

Dozer shovel large protection plate, pipeline layout protection, chassis hose protection, control box, instrument, waterproof and dustproof switch LED light, super flexible pilot tube



■ Tailless Excavator



■ Excellent Operation Performance



■ Intelligent Instrument



■ LED Lights



■ Pedal, comfortable and anti-fatigue



■ Fuel Tank

A large variety of attachments for different applications

More than ten types of attachments

Hydraulic hammer, bucket, quick change device, log grabber, simple grab pliers, ditch clearing bucket, clamshell bucket, drilling tool, lawn mower, etc. More than 40 key working conditions are applied, with a wide range of working conditions. Various accessories, easy to change orchard planting, rural reconstruction, engineering construction, greenhouse breeding, road crushing, digging ditches and repairing canals, drilling holes and planting trees.

Bucket



Log grapple



Narrow bucket



Twist drill



KEYPOWER Attachments

Breaker



Quick coupler



Scarifier



Garden rake



KP25-8 Features and Advantages

Power System



- Yanmar Engine (Other engine brands available)
- Power/speed (kW/rpm): 20.4kW/2200rpm;
- Naturally aspirated engine.
- Maximum torque/speed (Nm/rpm): 99-107.8Nm/ 1600rpm;
- Engine with muffler;
- Aluminum, oil-dispersed, water-dispersed parallel radiator.

Control System



- **Main control valve:** KYB (Optional)
- The generator and the hydraulic system are perfectly matched, and the working device works more smoothly

Operating System



- **Excellent Operation Performance:** The compound movements of the tooling device are coordinated and smooth; the control is precise with soft touch; the travelling is powerful and smooth without jumping; the whole machine is stable and has no nodding and cocking; without impact and abnormal noise.
- **Full Pilot Control:** The driving experience is more comfortable and the excavator moves more smoothly.

Travel System



- **Tailless rotation+Boom side shift**
- The two functions are used together to easily cope with narrow and complex conditions such as indoor, tunnel, pit and so on.
- The side shift Angle of the boom is larger with the same level, working in small Spaces has obvious advantages

Travel System



- Replaceable Tracks
- Rubber tracks and replaceable steel tracks are used by default, which can be replaced without replacing the support wheel.

Travel System



- **Travelling motor:** KYB (Optional)
- High and low speed switching

Swing arm x Bucket arm

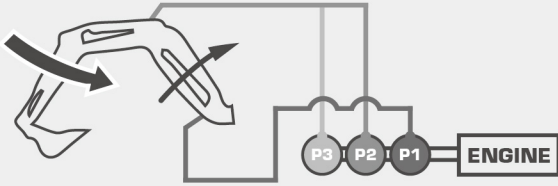

Bucket arm x Bucket

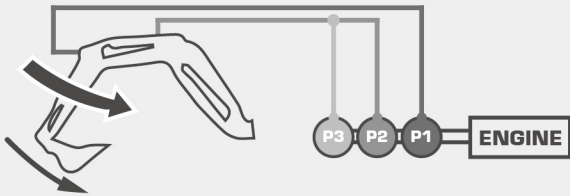

Swing arm x Rotation x Bucket arm

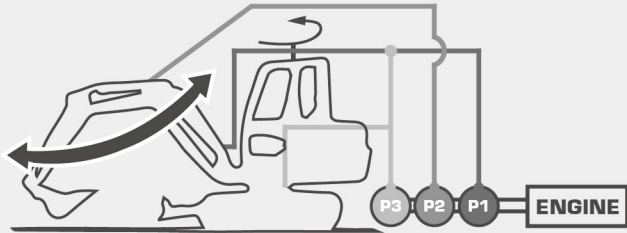

Three-pump Features

Three-pump confluence diagram

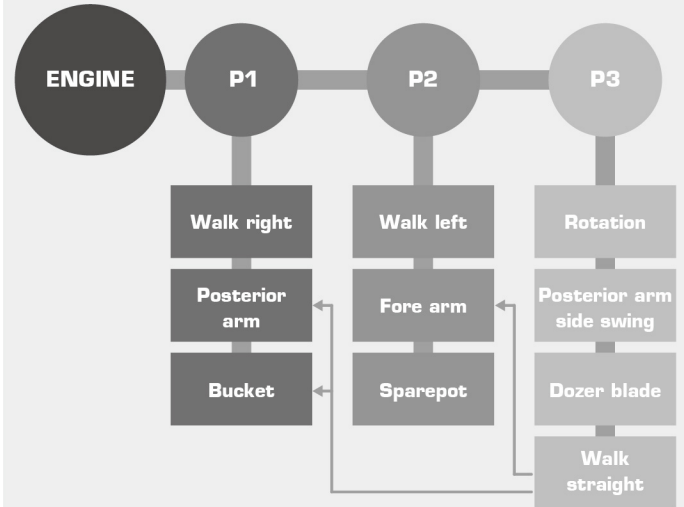

(Hydraulic system) Innovative three-pump system

The most optimal flow control, Even compound operation will not affect the operation of the working device based on demanding, near-perfect engine and hydraulic system matching technology, KEYPOWER's full range of excavators uses an innovative three-pump system in order to increase power output, improve operational efficiency and reduce fuel consumption.

